

**ASSEMBLY INSTRUCTIONS
MODEL NUMBER W26116-1**

**THANK YOU FOR PURCHASING THIS TABLE LAMP.
PLEASE FOLLOW THE INSTRUCTIONS LISTED BELOW:**

**CAUTION: DO NOT PLUG INTO WALL OUTLET BEFORE ASSEMBLY.
UNPLUG WHEN REPLACING THE LAMP BULB.**

1. Carefully unpack carton and place all parts on a soft, smooth surface. Inventory all parts.
2. Thread the body pipe and socket assembly (B) clockwise to base (A).
3. Attach harp (D) into the saddle (C).
4. Place the shade (E) onto top of harp (D).
5. Screw and tighten Finial (F), clockwise onto harp (D).

IMPORTANT SAFETY INSTRUCTIONS:

This portable lamp has a polarized plug (one blade is wider than the other), as a safety feature to reduce the risk of electric shock. This plug will fit in a polarized outlet only one way. If it does not fit fully in the outlet, reverse the plug. If it still does not fit, contact a qualified electrician. Never use with an extension cord unless plug can be fully inserted. Do not alter this plug.

Care and Maintenance

To clean, wipe with a soft dry cloth.

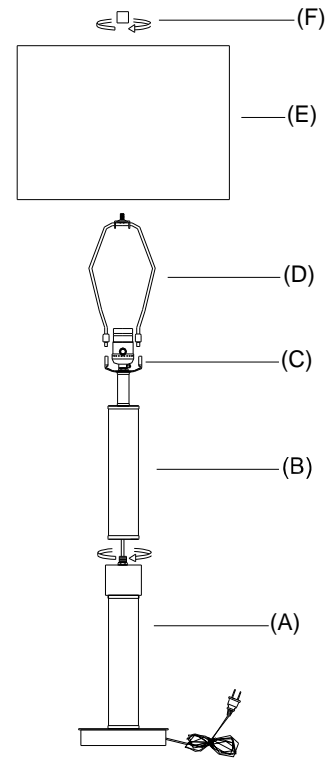

**ASSEMBLY INSTRUCTIONS
MODEL NUMBER W26116-1**

**THANK YOU FOR PURCHASING THIS TABLE LAMP.
PLEASE FOLLOW THE INSTRUCTIONS LISTED BELOW:**

**CAUTION: DO NOT PLUG INTO WALL OUTLET BEFORE ASSEMBLY.
UNPLUG WHEN REPLACING THE LAMP BULB.**

1. Carefully unpack carton and place all parts on a soft, smooth surface. Inventory all parts.
2. Thread the body pipe and socket assembly (B) clockwise to base (A).
3. Attach harp (D) into the saddle (C).
4. Place the shade (E) onto top of harp (D).
5. Screw and tighten Finial (F), clockwise onto harp (D).

IMPORTANT SAFETY INSTRUCTIONS:

This portable lamp has a polarized plug (one blade is wider than the other), as a safety feature to reduce the risk of electric shock. This plug will fit in a polarized outlet only one way. If it does not fit fully in the outlet, reverse the plug. If it still does not fit, contact a qualified electrician. Never use with an extension cord unless plug can be fully inserted. Do not alter this plug.

Care and Maintenance

To clean, wipe with a soft dry cloth.

