

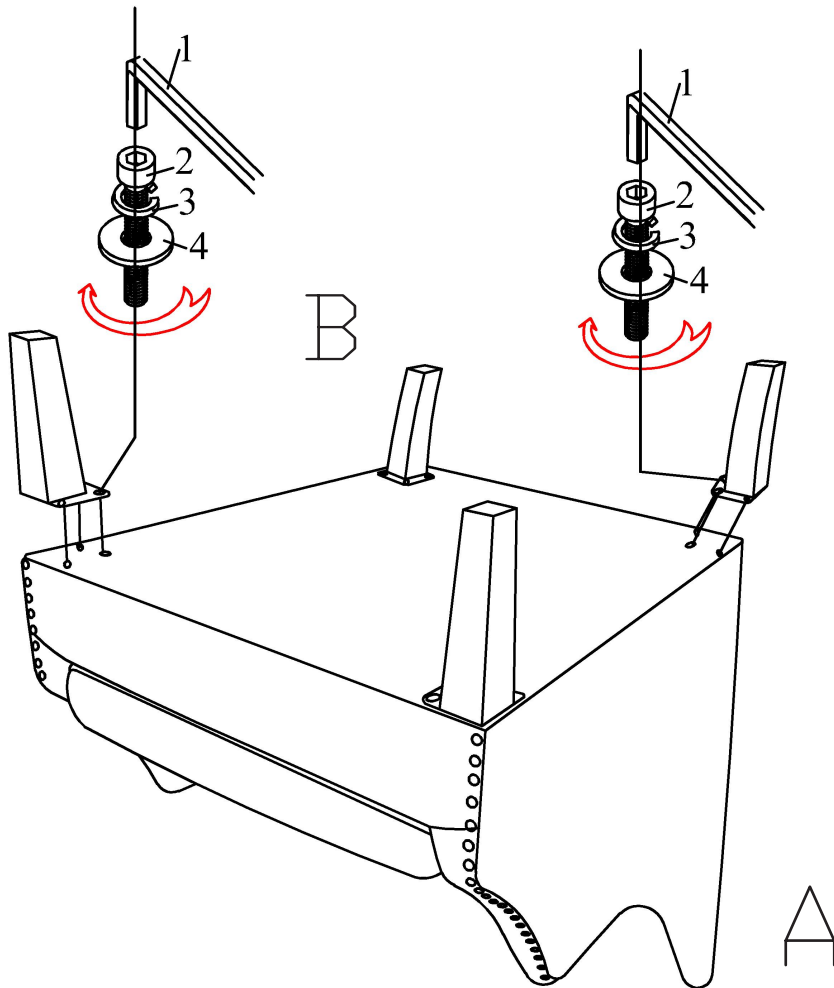

UTTERMOST

Assembly Instruction

23370



1. Take the parts carefully out of the carton, and place it on a flat surface, make sure that the parts will not be damaged.

2. Use the bolt and washer to secure the legs (B) to the seat (A)

Hardware and tool included: wrench, bolt, spring washer, flat washer.

To Clean, wipe with soft dry cloth.