







# REVELATION

by UTTERMOST

## ASSEMBLY INSTRUCTIONS

ITEM NO.: R25212

ITEM	PART NAME	QTY
1	Table Top	1
2	Leg	2
3	Connecting	1
4	Extension plate	2

ITEM	PART NAME	QTY
A	Flat washer 	14
B	Lock washer 	14
C1	Bolt (longer) 	12
C2	Bolt (shorter) 	2
E	Allen wrench 	1
F	Big bolt 	6

Step 2

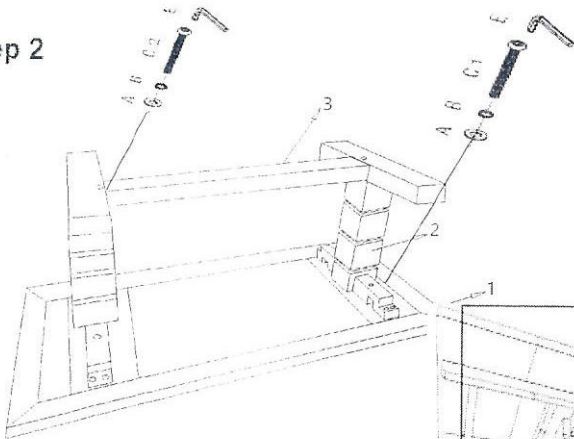

Step 5:

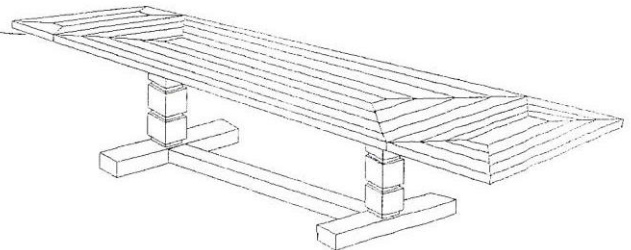
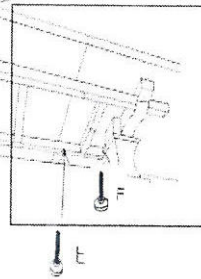
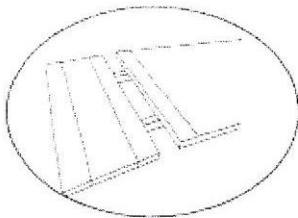

**Step 1:** Take the parts carefully out of carton, and then place them on a flat and soft surface, making sure that parts will not be damaged.

**Step 2:** Attach Leg(2) and Connecting(3) to Table Top(1) by using Longer Bolts(C1), Washers(A) and Lock Washers(B), When assembling install all bolts before securing any one bolt.

**Step 3:** Attach connecting into leg use shorter bolts (C2) lock washer (D), flat washer (A).

**Step 4:** Stand up the table after installation.

**Step 5:** When you need you can extend the plates into the table and fixed with F.

P.O. Box 558 | 3325 Grassy Hill Road | Rocky Mount, VA | 24151

[www.uttermost.com/Revelation](http://www.uttermost.com/Revelation)