







REVELATION

by UTTERMOST

Assembly instruction ITEM NO.:R24899

ITEM	PART NAME	QTY
1	Table Top	1
2	Leg	2
3	Connecting	1
4	Extension plate	2

ITEM	PART NAME	QTY
A	Flat washer 	14
B	Lock washer 	14
C	LONGER BOLT 	12
C1	SHORTER BOLT 	2
E	ALEN WRENCH 	1
F	Big bolt 	6

Step 2

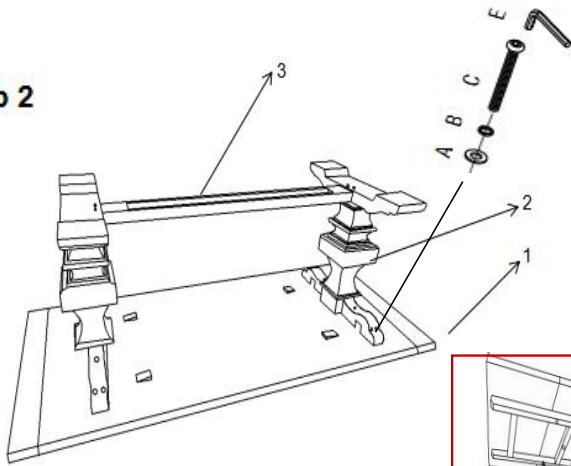

Step 5:

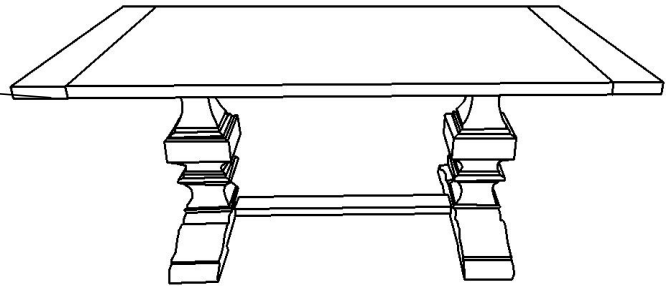
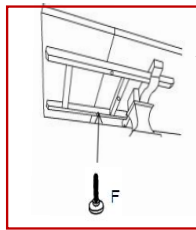

Step1. Take the parts carefully out of carton, and then place them on a flat and soft surface, making sure that parts will not be damaged.

Step 2: Attach Leg(2) and Connecting(3) to Table Top(1) by using Bolts(C), Washers(A) and Lock Washers(B) ,

Step 3: Attach connecting into leg use bolts (C)lock washer (D),flat washer (A).

Step 4: Stand up the table after installation.

Step 5: When you need you can extend the plates into the table and fixed with F.

PO BOX 558/3325 GRASSY HILL RD. ROCKY MOUNT, VIRGINIA 24151
www.revelationbyuttermost.com