









UTTERMOST

Assembly instruction ITEM NO.:R24648

ITEM	PART NAME	QTY
1	Table Top	1
2	Panel	2
3	Connecting	1
4	Extension plate	2

ITEM	PART NAME	QTY
A	Flat washer 	14
B	Lock washer 	14
C	Long BOLT 	12
D	Short BOLT 	2
E	ALEN WRENCH 	1
F	Big bolt 	6

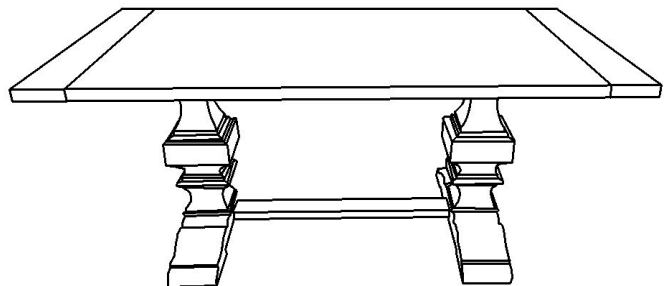
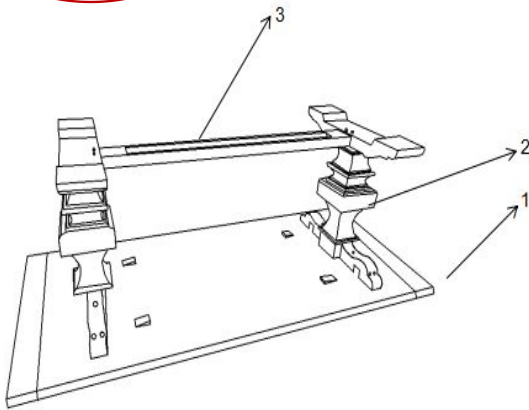
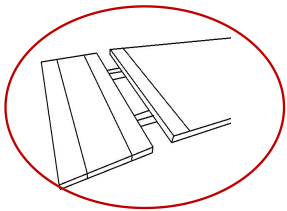

Step1. Take the parts carefully out of carton, and then place them on a flat and soft surface, making sure that parts will not be damaged.

Step 3: Attach Panels(2) and Connecting(3) to Table Top(1) by using longer Bolts(C), Washers(A) and Lock Washers(B) ,

Step 4: When you need you can extend the plates into the desk and fixed with F

Step 5: Stand up the table after installation.