

# REVELATION

by UTTERMOST

## ASSEMBLY INSTRUCTIONS

# Illustration

STYLE NO. : R21593

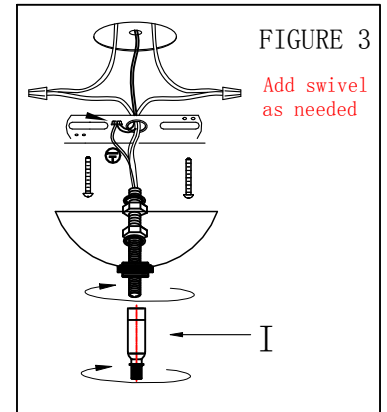
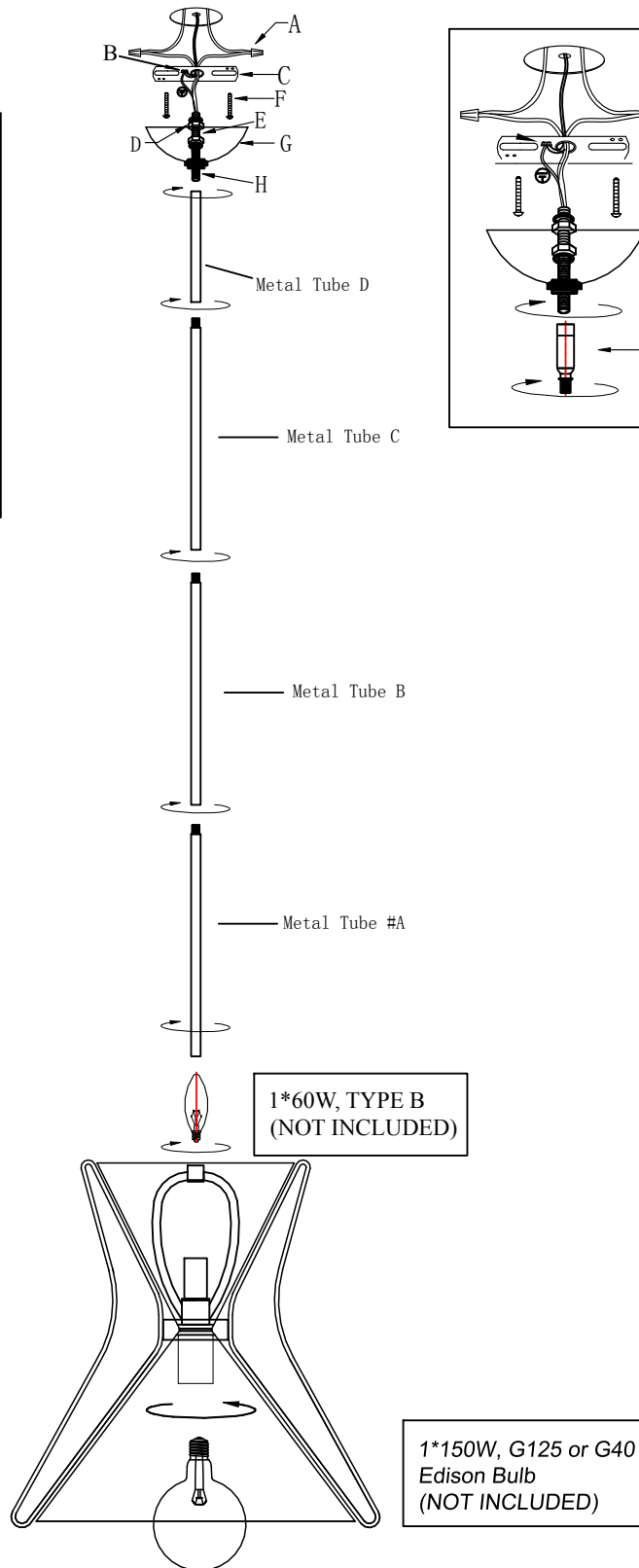
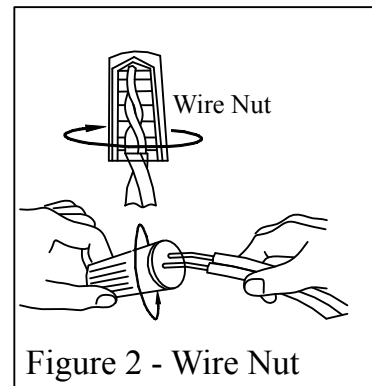
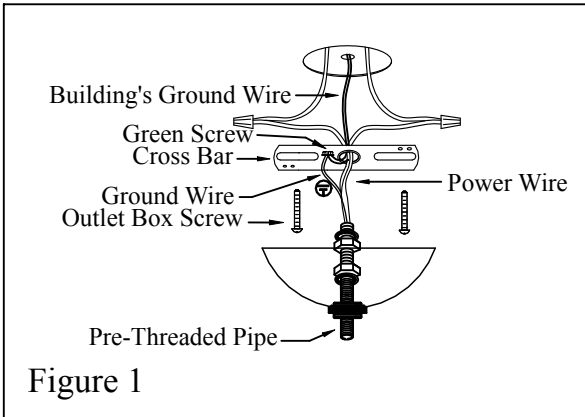

# REVELATION

by UTTERMOST

## ASSEMBLY INSTRUCTIONS

STYLE NO. : R21593

### Parts and Hardware List

<b>A.</b>	<b>Wire Nut</b>	<b>3PCS</b>
<b>B.</b>	<b>Green Ground Screw</b>	<b>1PC</b>
<b>C.</b>	<b>Crossbar</b>	<b>1PC</b>
<b>D.</b>	<b>Hex Nut</b>	<b>2PCS</b>
<b>E.</b>	<b>Pre-Threaded Pipe</b>	<b>1PC</b>
<b>F.</b>	<b>Outlet Box Screw</b>	<b>2PCS</b>
<b>G.</b>	<b>Canopy</b>	<b>1PC</b>
<b>H.</b>	<b>Pre-threaded Ring</b>	<b>1PC</b>
<b>I.</b>	<b>Swivel</b>	<b>1PC</b>

**WARNING: BEFORE INSTALLING**, make sure the electricity supply is shut off to avoid a possible electric shock. We suggest a licensed electrician for all lighting fixture installations.

Please make sure that you have all the parts indicated before you begin assembling this item.  
Please read Wiring Instructions before you begin assembling and installing your lamp.

### Assembly Instruction

1. Carefully remove the parts and hardware from the carton.
2. Fasten the Crossbar (C) onto the Outlet Box by using the Outlet Box Screws (F).
3. Insert the shorter end of the Pre-Threaded Pipe (E) into the pre-drilled hole in the Crossbar (C) and secure with the Hex Nuts (D). (See illustration)
4. Attach the Pre-threaded Ring (H) to the exposed end of the Pre-Threaded Pipe (E) and secure by turning in a clockwise direction.
5. Screw swivel (I) on the Canopy as needed, and another end of swivel to screw on one end of the metal tube D. (See Figure 3) If you don't need swivel, you can screw the metal tube D on canopy directly.
6. Adjust the length of the wire needed for your installation, remove excess, determine the number of Rods to be assembled to the Fixture Body as needed for your hanging height, then screw the Lamp body onto the Metal Tube A until tight.
7. Repeat the Step 6 with the Metal Tube B, C and D as needed for your installation height.
8. Install both ground wires in the Crossbar (C) with the Green Ground Screw (B) supplied.
9. Place the white wire, ribbed or tinted wire evenly against the white wire from the outlet box and place the black, smooth or un-tinted wire evenly against the black wire from the outlet box. (Connecting the Wires - See Figure 2)
10. After the wires are connected, tuck them carefully inside the outlet box. Place the Canopy (G) over the outlet box and secure with Pre-Threaded Ring (H).
11. Install 1\*60W max, Type B bulbs (NOT INCLUDED) into the top sockets of the fixture, and install 1\*150W, G125 or G40 Edison Bulb (NOT INCLUDED) into the bottom socket of the fixture.