

REVELATION

by UTTERMOST

ASSEMBLY INSTRUCTIONS

STYLE# R21507

WARNING: TO AVOID RISK OF ELECTRICAL SHOCK, BE SURE TO SHUT OFF POWER BEFORE INSTALLING OR SERVICING THIS FIXTURE.

Carefully unpack all lamp parts from carton. We suggest a licensed electrician for all fixture installations.

1. Take the parts carefully out of the carton, Place them on a flat surface, and make sure the parts will not be damaged.
 2. Remove the **Ball finial** under the **Canopy** from the **Mounting Screws**, and take out the **Universal Bar**. Attach the **Universal Bar to the Outlet Box** by using **Four Outlet Box Screws**. (See Figure 1)
 3. Adjust the lengths of rod hung holding each glass, to the lengths you desire. WE HAVE PRESET THE ROD HUNG LENGTHS AS SHOWN IN OUR ASSEMBLY. You are welcome to adjust the rod hung length to your own need. But it's essential to add EXACTLY same rod for each glass, i.e, if you want to add a 12" rod for one glass, then the rest of four glasses also need to add a 12" rod at the same time. Make sure to remove extra wire, making sure you don't leave it attached or tucked in the canopy.
 4. After determine the number of **Rods** to be assembled to the **Fixture Body** as needed for your hanging height. Pull the **Supply Wire** with **Ground Wire** through the selected **Rods** and **Swivel**. Thread the **Rods & connect Nipple**. Hand tighten.
 5. Pass the supply wire through the **Universal Bar** assembly, secure the **Universal Bar** to the **Outlet Box** with **Outlet Box Screws**.
 6. For each of the 5 cords draw all of the wires together as follows:
 - a. Connect the **House Ground Wire** to the **Fixture Ground Wire**, secure with wire nut.
 - b. Connect the **House White (or Ribbed) Wire** to the **Fixture Supply Wire (White or Ribbed Side)**, secure with wire nut.
 - c. Connect the **House Black (or Red) Wire** to the **Fixture Supply Wire (Black or Smooth Side)**, secure with wire nut.
 - d. Carefully stuff all of the connected wires into the **Outlet Box**.Tuck them carefully inside the **Outlet box**. (See Figure 2)
 7. Place the **null wire, white wire** evenly against the **null wire** from the **Outlet Box** and place the **live wire, black wire** evenly against the **live wire** from the **Outlet Box**. (Connecting the Wire---See Figure 3)
 8. Place the **Canopy** over the **Mounting Screws** and secure with **Mounting Balls**. Hand-tighten until snug.
 9. Slide **Glass Shade** over socket and thread **Metal Sleeve** onto **Socket**. Then use **Plastic Wrench** to lock the **Socket Collar** onto the socket to secure the **Glass Shade**. Tighten until snug. (See Figure 4)
 10. Install the correct **Bulb (Bulb Not Included)** into the **Socket** until snug.
- Your installation is completed now. Restore electricity.**

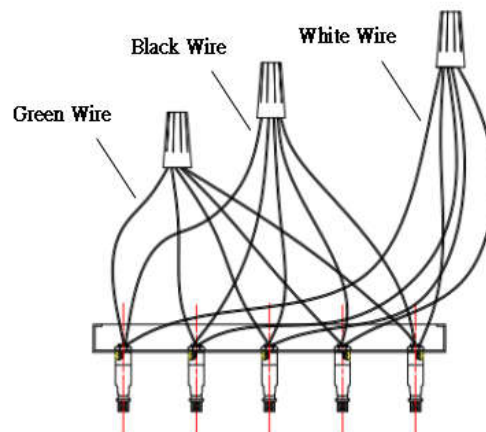
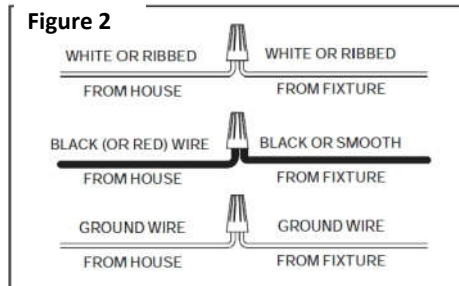
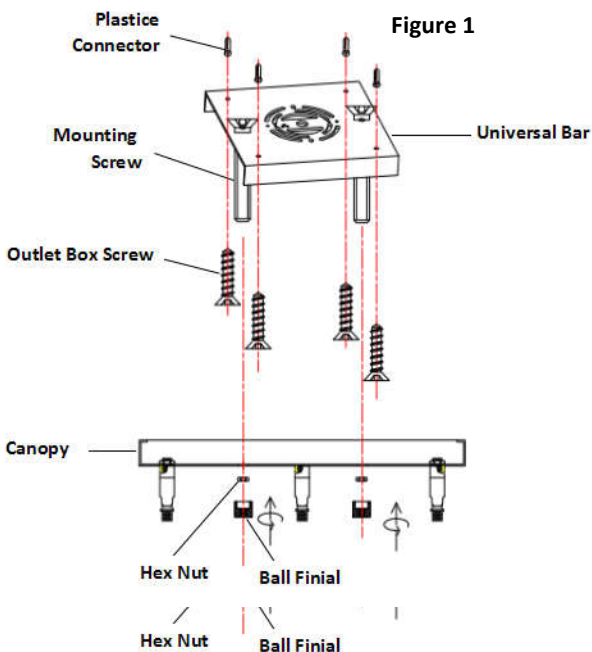

REVELATION

by UTTERMOST

ASSEMBLY INSTRUCTIONS

STYLE# R21507

WARNING: TO AVOID RISK OF ELECTRICAL SHOCK, BE SURE TO SHUT OFF POWER BEFORE INSTALLING OR SERVICING THIS FIXTURE.

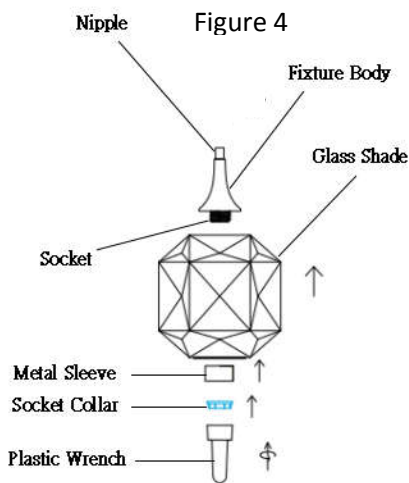
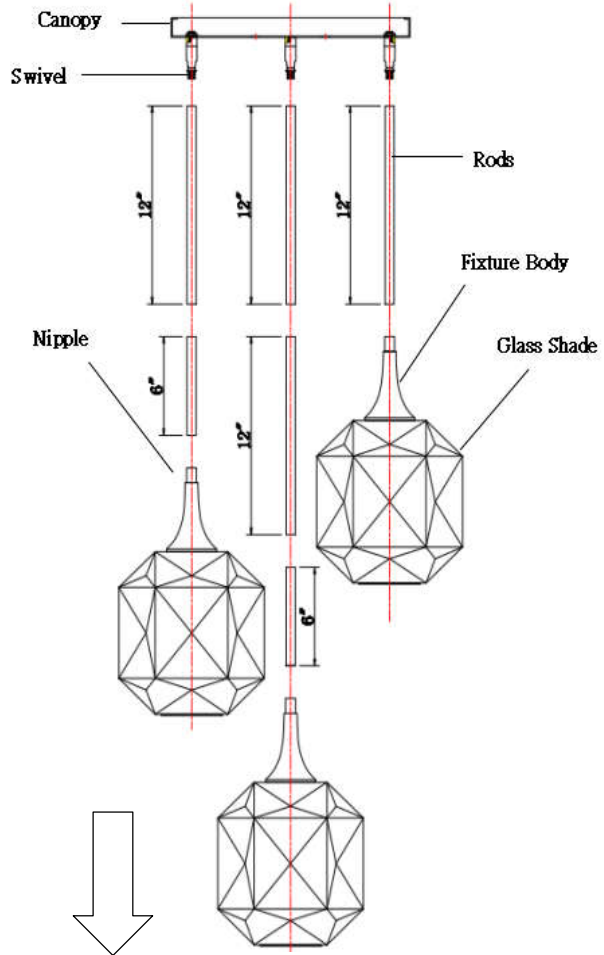
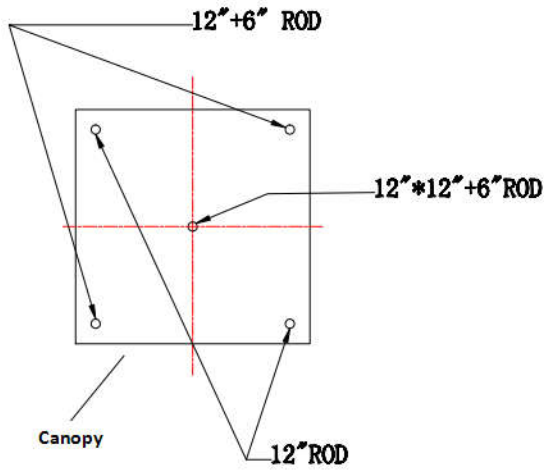
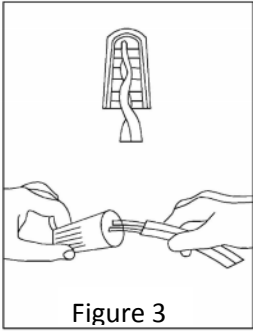

PO BOX 558/3325 GRASSY HILL RD. ROCKY MOUNT, VIRGINIA 24151

www.uttermost.com