

REVELATION

by UTTERMOST

Assembly Instructions





ITEM# R25391

Component List:

Dining table top A..... 1 pc

Dining table Base B.....1 pc

Dining table Extension Board C..... 1 pc

No.		Hardware list	q'ty
D		Bolt $\frac{5}{16}$ " x 1 $\frac{3}{8}$ "	6
E		Flat Washer $\frac{5}{16}$ "	6
F		Lock Washer $\frac{5}{16}$ "	6
G		Allen wrench 2 $\frac{7}{8}$ " x 1 $\frac{1}{4}$ " x $\frac{1}{5}$ "	1

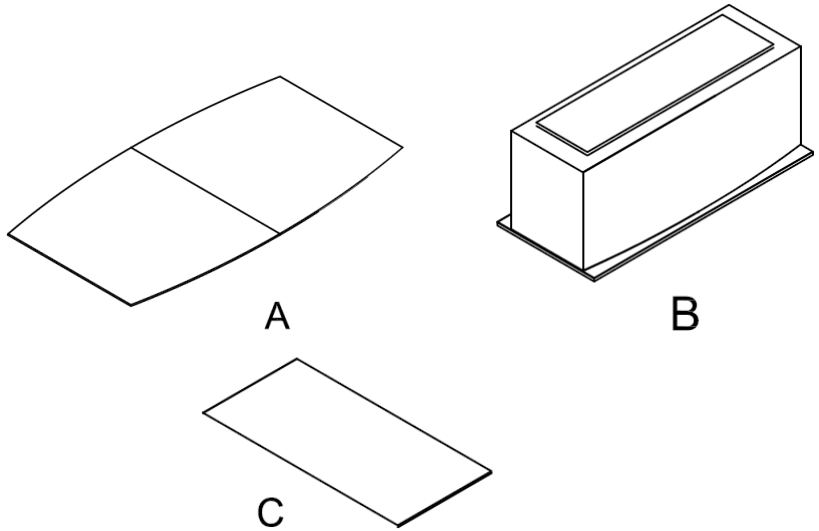

Step 1. Assemble Dining Table Base (B) on to the **Dining Table Top (A)** by using **Bolt (D)**, **Flat washer (E)**, **Lock washer (F)**, & **Allen washer (G)** to tighten .As show on right Diagram.

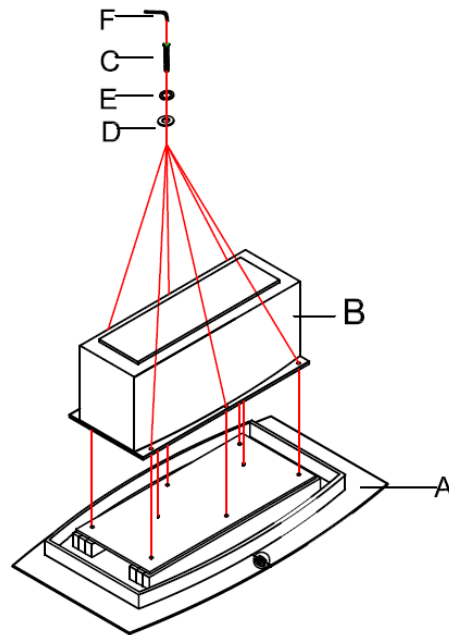

Diagram 1

Step 2. Turn the Dining table upward.

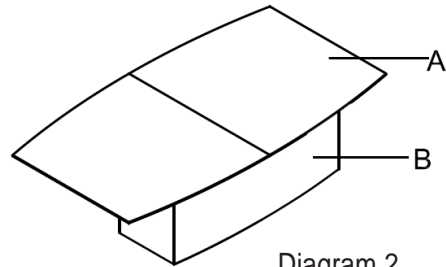

Diagram 2

Step 3. Turning the lock on the **Dining Table Top (A)** (see Diagram 2) and pull the **Dining Table Top (A)** out on both side (see Diagram 4) , then put the **Dining Table Top Extension Board (C)** onto **Dining Table Top (A)**

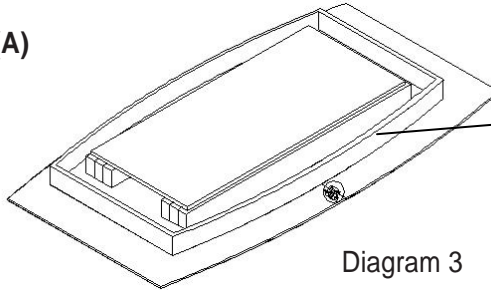

Diagram 3

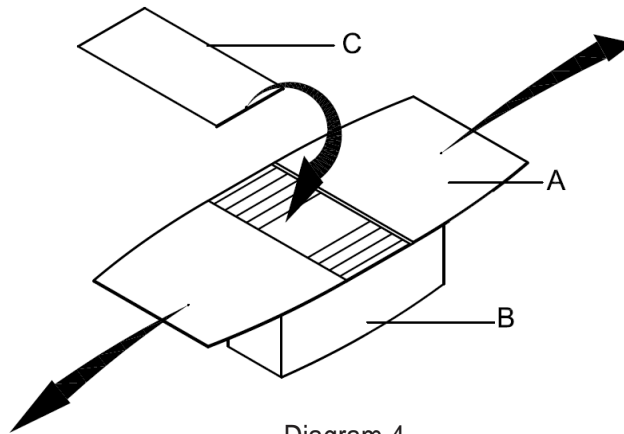
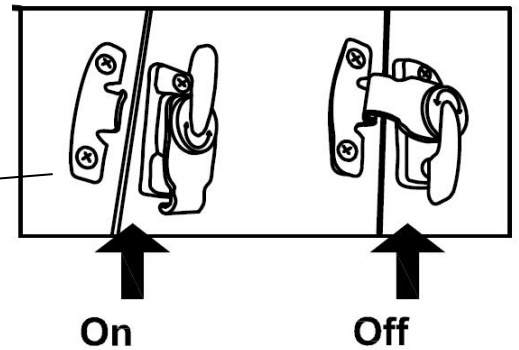
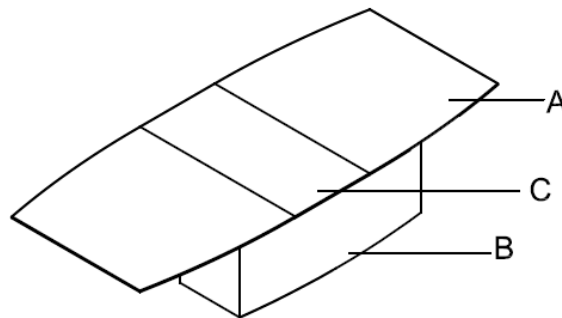

Diagram 4

Step 4. Push the **Dining Table Top (A)** closed and turn the lock off .



Assembly is complete now.
Thank you for your purchase.