

REVELATION

by UTTERMOST

ASSEMBLY INSTRUCTION FOR ITEM #R25406

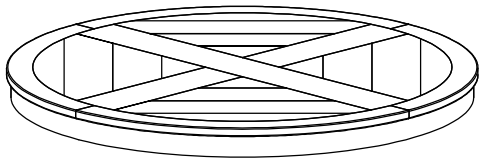

1 Top - 1 pc.

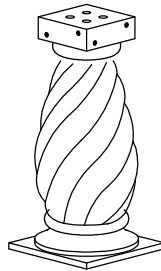

2 Center Leg - 1 pc.

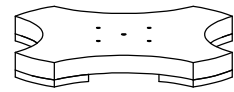

3 Base - 1 pc.

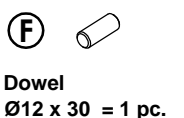
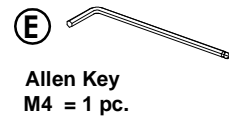
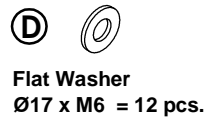
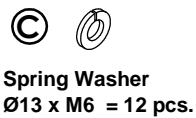

1

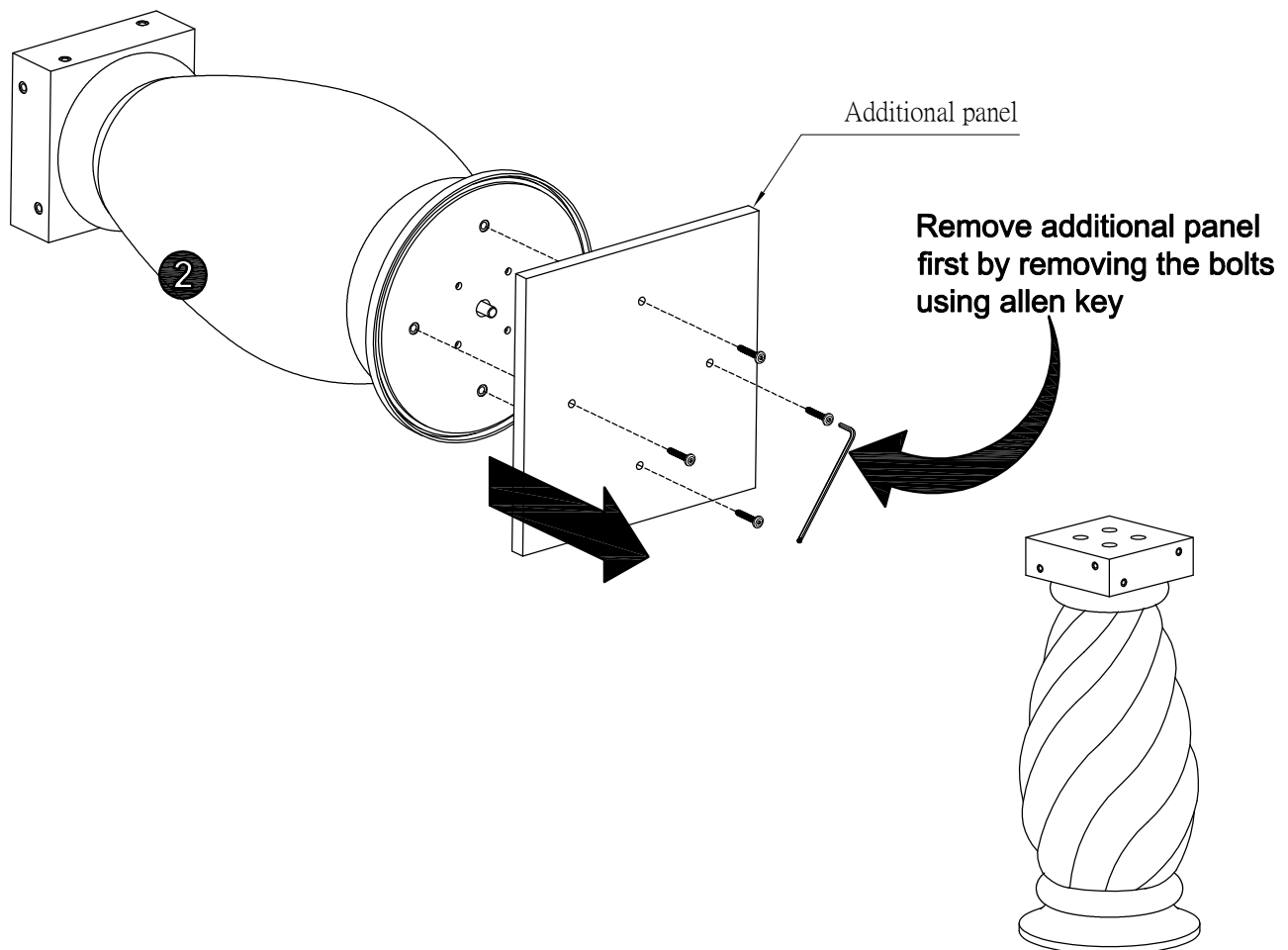

REVELATION

by UTTERMOST

ASSEMBLY INSTRUCTION FOR ITEM #R25406

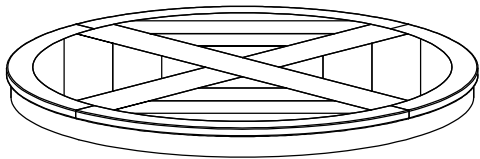

1 Top - 1 pc.

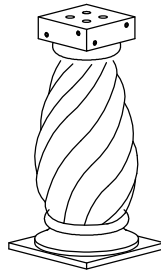

2 Center Leg - 1 pc.

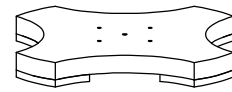

3 Base - 1 pc.

