

UTTERMOST

ASSEMBLY INSTRUCTIONS

STYLE#:25178

Carefully unpack all Assembly parts from the carton.

1. Take Table carefully out of the Carton, and place the **Base** in an upright position on the floor.
2. Thread the **Table Top** onto the top of **Base** carefully, and turn clockwise to tighten it.

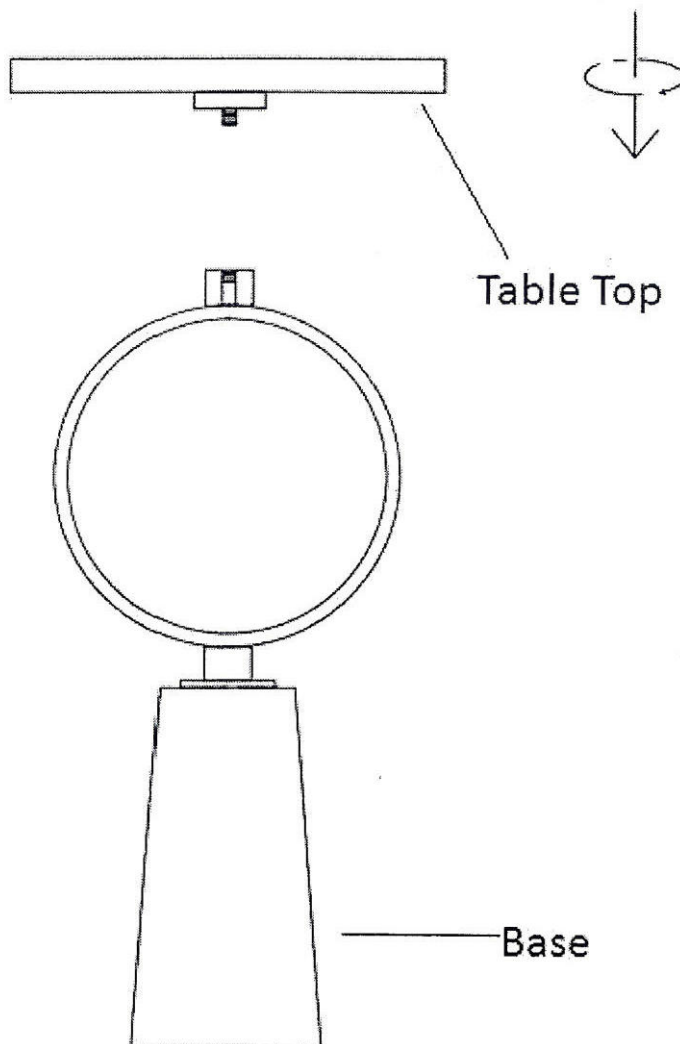

25178