







# Assembly Instruction

## STYLE:24409

### Parts list

A	LEGS	2PCS
B	TABLE TOP	1PCS

### Hardware list

	WRENCH	1PCS
	FLAT WASHERS	4PCS
	SCREW	4PCS
	CROSS SCREW	6PCS
	CROSS SCREW DRIVER	1PCS

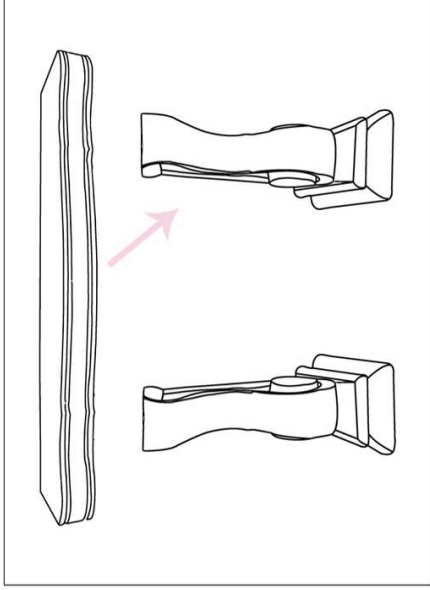

1. Take the parts carefully out of the carton, and then place them on a flat and soft surface, making sure that the parts will not be damaged.

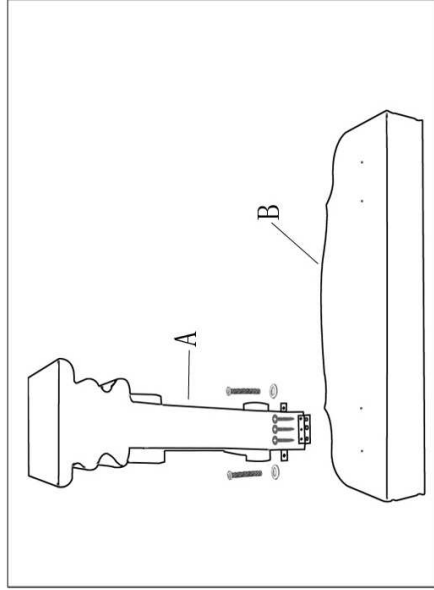

2. Place the table top upside down on a flat and soft surface, then screw the Table Leg into the screw holes under the bottom of Table Top, and then use wrench to secure tightly.

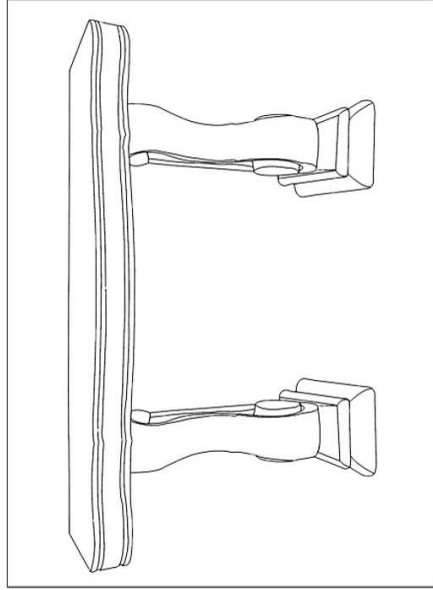

3. Screw the hinge into the bottom of Table Top by cross screwdriver.

4. Turn table over and the assembly is completed.

To clean, wipe with soft dry cloth.