













UTTERMOST

ASSEMBLY INSTRUCTIONS

ITEM:23577

PARTS LIST							
NO	DRAWING	PARTS NAME	Q'TY	NO	PARTS NAME	DRAWING	Q'TY
M		BOLTS DIA $\phi 1/4"$ *2-1/2"	4PCS	1	BACK FRAME		1PC
S		BOLTS DIA $\phi 1/4"$ *1-3/4"	1PC	2	SEAT CUSHION		1PC
L		BOLTS DIA $\phi 1/4"$ *3-1/2"	4PCS	3	LEFT SIDE STRETCHER		1PC
D		LOCK WASHER $\phi 1/4"$	9PCS	4	RIGHT SIDE STRETCHER		1PC
E		FLAT WASHER $\phi 1/4"$ *3/4"	9PCS	5	CROSS BAR		1PC
F		ALLEN WRENCH 1/4"	1PC	6	FRONT LEG		2PCS
G		MUSHROOM HEAD SCREW #8*1-5/8"	6PCS	ASSEMBLY BOLTS MAY NEED TIGHTEND AFTER USE			

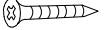
STEP:1 Put the Back Frame (1) and Seat Cushion (2) together, use one Short Bolt (S) to fix the Back Frame (1) and Seat Cushion(2) in the Center, and use four Long Bolts (L) to fix the two back legs. **Do not tighten All the Bolts until Step (5) is completed.**

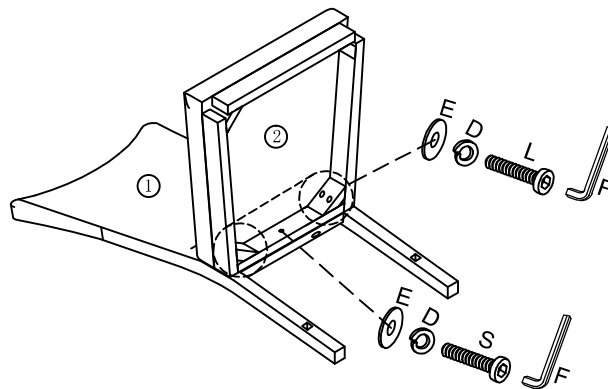

STEP:2 Attach the two Front Legs(6) into the holes on the Seat Cushion (2) and use four Medium Length Bolts(M) to fix. Please note that the Left Leg label in Blue goes into the Hole label in blue, and Right Leg label in Red goes into the Hole label in Red. Do not tighten All the Bolts until Step (5) is completed.

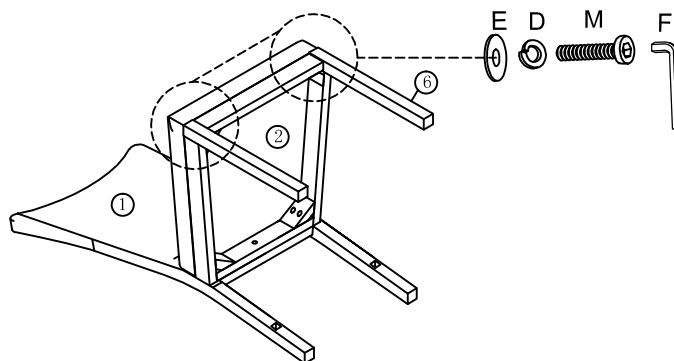

UTTERMOST

ASSEMBLY INSTRUCTIONS

ITEM:23577

STEP:3 Put the Left Side Stretcher (3) into the Left Hole of the back Frame, and the Left Hole of the front Left Leg. And the same assembly for the Right Side Stretcher (4) into the Right Hole of Back Leg, and the Right Hole of the front Leg. of the legs. Please note that Blue and Red labels are used on the ends of the Stretchers and the Holes.

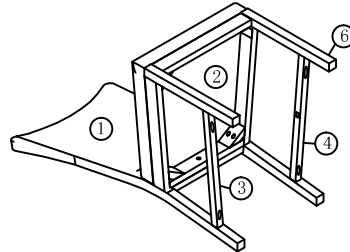

STEP:4 Then use the Cross Bar (5) to connect the Left Stretcher(3) and the Right Stretcher(4). Please make sure the screws holes of the stretchers are facing DOWNWARD of the chair and the screw holes of the cross bar are facing BACKWARD of the chair. Then use six Mushroom Head Screws (G) to secure them. Screw Driver is needed here (not included)

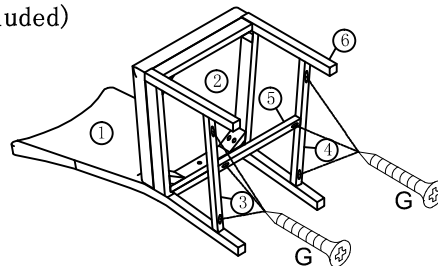

STEP:5 Then set the Chair on a flat surface, make sure all the Legs are in same Level and then use the Allen Wrench(F) to tighten all the Bolts until secure.

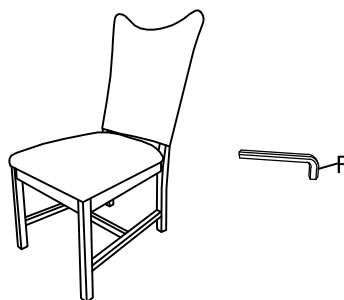

STEP:6 Put the Cover On and the assembly is completed.

