









UTTERMOST

ASSEMBLY INSTRUCTION

ITEM:23312

PARTS LIST

NO	DESCRIPTION	SKETCH	NO	SKETCH	DESCRIPTION	Q'TY
A	 BOLTS DIA 5/16"X2"	8PCS	1		SEAT FRAME	1PC
B	 LOCK WASHER 5/16"	8PCS				
C	 FLAT WASHER 5/16"X 3/4"	8PCS	2		FRONT LEG	2PCS
D	 ALLEN WRENCH 5/16"	1PC				
			3		BACK LEG	2PCS

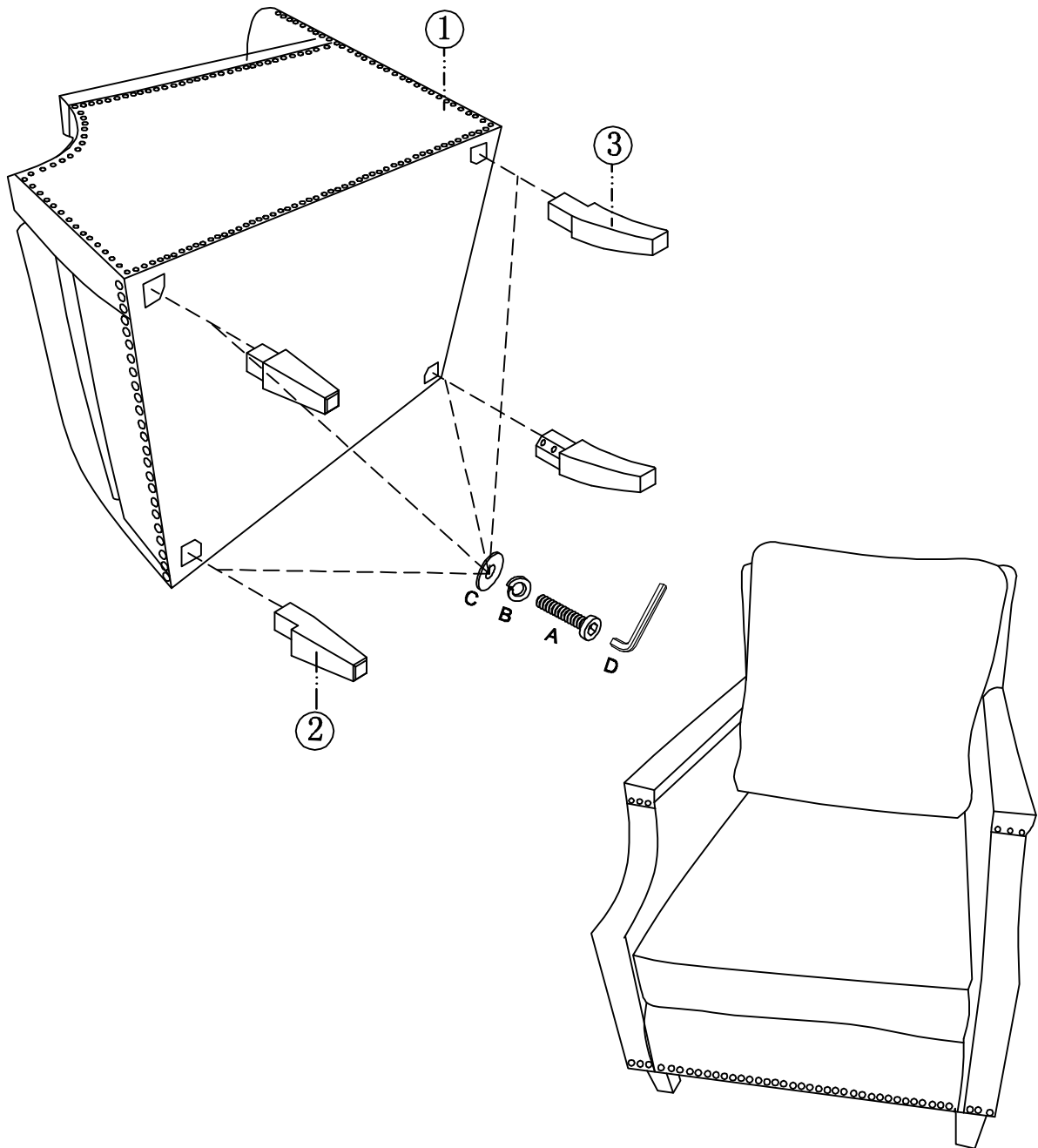

PO BOX 558/3325 GRASSY HILL RD. ROCKY MOUNT, VIRGINIA 24151 WWW.UTTERMOST.COM