











UTTERMOST

ASSEMBLY INSTRUCTION

ITEM: 23305

PARTS LIST

NO	DRAWING	PARTS NAME	Q'TY	NO	PARTS NAME	DRAWING	Q'TY
A		FLAT WASHER 5/16" X 3/4"	8PCS	1	SEAT FRAME		1PC
B		LOCK WASHER 5/16"	8PCS				
C		BOLTS DIA 5/16" X 2"	4PCS	2	FRONT LEG		2PCS
D		BOLTS DIA 5/16" X 2-1/2"	4PCS				
E		ALLEN WRENCH 5/16"	1PC	3	BACK LEG		2PCS

ASSEMBLY BOLTS MAY NEED TIGHTEND AFTER USE

STEP 1

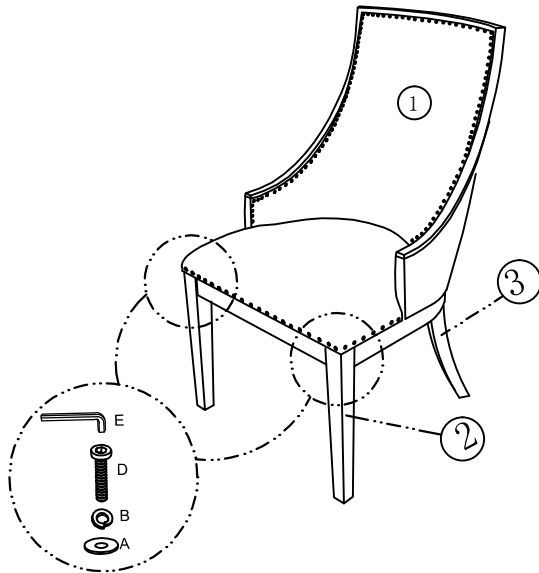

STEP 2

